

# Instruction Manual

**UHF PLL**

## US-936K/Mh-936K

### Dual Channel Wide Bandwidth Wireless System

JTS<sup>®</sup> PROFESSIONAL CO., LTD

[www.jts.com.tw](http://www.jts.com.tw)  
[www.maxlight.ru](http://www.maxlight.ru)

FC CE 1856  RoHS  59508-047-01

# INDEX

1. Important Caution	1
2. Features	1
3. Specification	2
3-1 UHF PLL Dual Channel Diversity Receiver // US-936K	2
3-2 UHF PLL Handheld Transmitter // Mh-936K	2
4. Part Identification & Accessories	3
4-1 UHF PLL Dual Channel Diversity Receiver // US-936K	3
4-2 UHF PLL Handheld Transmitter // Mh-936K	6
4-3 Accessories	6
5. Connection	7
6. Operation	8
7. Recommendation	13
8. Important Notice	14

Thank you for choosing the JTS wireless system. In order to obtain the best efficiency from the system, you are recommended to take a few minutes to read this instruction manual carefully.

# 1. Important Caution

- Always makes all connections before plugging the unit into an AC power outlet.
- Do not leave the device in a place neither with high temperature nor high humidity.
- Always do not handle the power cord with wet hands!
- Keep the devices away from fire and heat sources.
- Makes sure receiver/transmitter are in the same preset channel or frequency.

# 2. Features

- At super-wide band of 36 MHz, specially intended for exquisite KTV rooms and classrooms
- Operation functions designed to be user-friendly
- Preset with 225 pairs of channels
- Unprecedented 001-225 coded reception/transmission channels
- Dual channel (receiving) set with one key
- All-new D-36K highly sensitivity and anti-feedback capsule
- Adjustable squelch level at front panel

# 3. Specification

## 3-1 UHF PLL Dual Channel Diversity Receiver // US-936K

Frequency Preparation.....	PLL Synthesized Control
Carrier Frequency Range	36MHz within 502~960 MHz
S/N Ratio.....	>105dB
T.H.D.....	<0.6%@1KHz
Display.....	LCD/LED
Display Contents.....	Channel, Antenna A/B, Mute Display, RF/AF Level Meter, Low battery, SQ
Controls.....	Power On/Off, Frequency Up/Down, Volume, SQ, Preset channel 001~225
Audio Output Level.....	-12dB
AF Output Impedance.....	600Ω
Operation Voltage.....	12-18 VDC, 500mA
Output Connector.....	3 unbalanced Ø6.3mm phone jack
Dimension(m/m).....	210mm(W) * 40mm(H) * 172mm(D)

## 3-2 UHF PLL Handheld Transmitter // Mh-936K

Frequency Preparation.....	PLL Synthesized Control
Carrier Frequency Range.....	502~960 MHz
RF Outputs.....	Lo:3mW , Hi:10mW (Depend on Local Regulation)
Stability.....	±10KHz
Frequency Deviation.....	±48KHz
LCD Display.....	Preset channel, Battery Fuel Gauge, Frequency
Controls.....	Power On/Off, Frequency Up/Down, Lock-on Mode, Preset channel, A or B channel select, RF outputs adjust, Gain control
Spurious Emissions.....	<-50 dBC
Audio Frequency Response	50~16,000 Hz
Battery.....	UM3, AA 1.5V*2

# 4. Parts Identification & Accessories

## 4-1 UHF PLL Dual Channel Diversity Receiver // US-936K

### Front panel

- ① Power Switch
- ② Lock on/off
- ③ Volume Control
- ④ Frequency
- ⑤ Squelch Adjustment
- ⑥ Channel Select
- ⑦ LED Channel Code Display
- ⑧ LCD Frequency Display

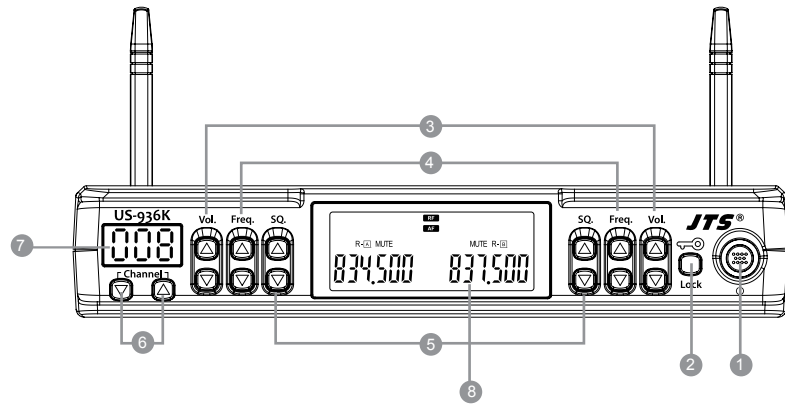

### LCD Panel of the Receiver

- ⑨ **RF** : RF Level: display the strength of radio signal
- ⑩ **AF** : AF Level: display the strength of audio signal
- ⑪ : Low battery indicator: display the low battery status of its transmitter
- ⑫ **R-(A)** : Channel A on Right side; **R-(B)** Channel B on Right side
- ⑬ **MUTE** : MUTE is displayed on screen when the receiver does not receive signals from the transmitter
- ⑭ : This antenna icon, indicating "Receiving", is displayed on screen when the receiver receives signals from the transmitter
- ⑮ LCD display: Displays frequency, volume and sensitivity; a corresponded value is displayed on screen when the receiver frequency, volume or sensitivity is being adjusted.
- ⑯ : Lock on: the panel keys have been locked by the "Lock" key and are unable to adjust or set.
- ⑰ **FREQ** : indicates the receiver frequency is being adjusted
- ⑱ **SQ** : indicates the receiver squelch level is being adjusted.

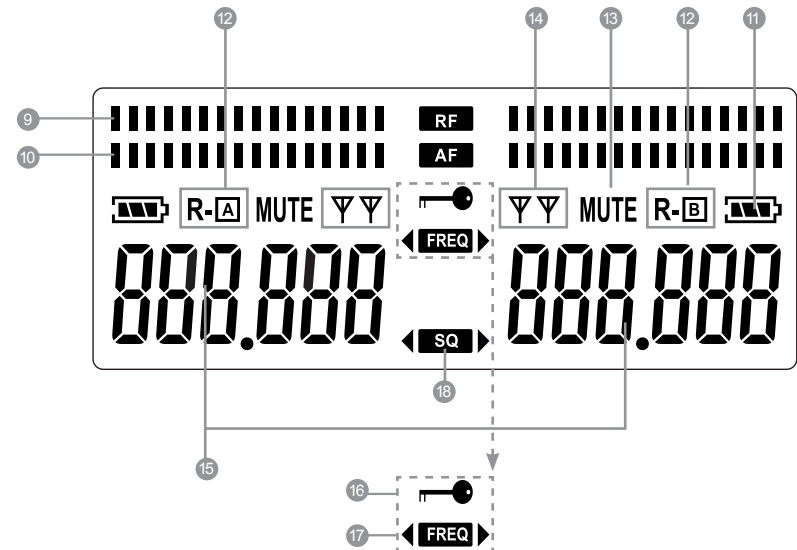

## Rear panel

- 19 Antenna
- 20 Balanced 6.3mm jack Output: for connection to the balanced input, e.g. of a mixer or an amplifier
- 21 Mixed AF Output (6.3mm jack, unbalanced): for connection to a balanced input, e.g. of a mixer or amplifier
- 22 Power Supply Jack (12-18V/500mA): for connecting the power supply unit

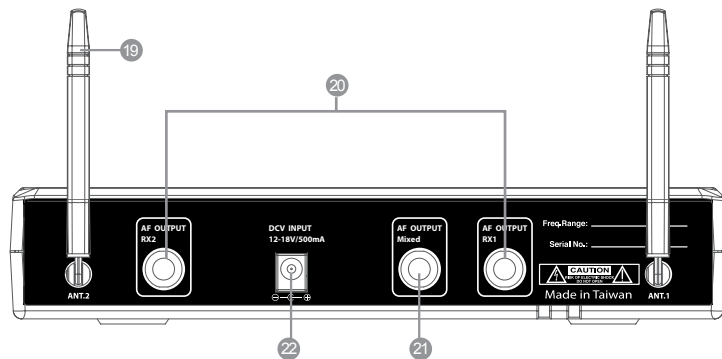

## 4-2 UHF PLL Handheld Transmitter // Mh-936K

- 23 LCD Display
- 24 Power and Mute Switch
- 25 ▲ : Up button: select the settings of transmitter
- 26 ▼ : Down button: select the settings of transmitter
- 27 Set button: set the configuration of handheld transmitter
- 28 Battery Tray

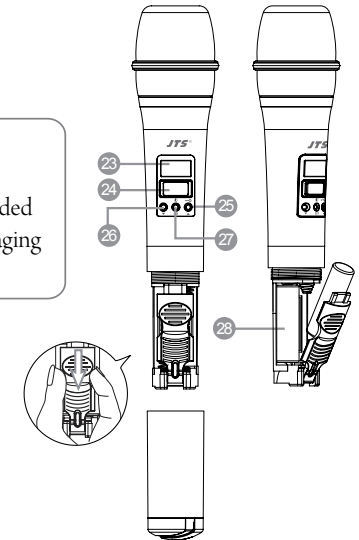
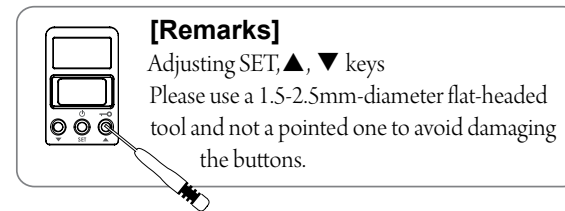

## 4-3 Accessories

- 29 AC/DC adaptor  
Switching Power Supply(100V~240V , 50~60Hz)  
AC IN: AC100~240V/50~60Hz  
DC OUT: DC12V/0.5A
- 30 AF output cable (with  $\Phi 6.3$  plug at both ends)
- 31 Screwdriver

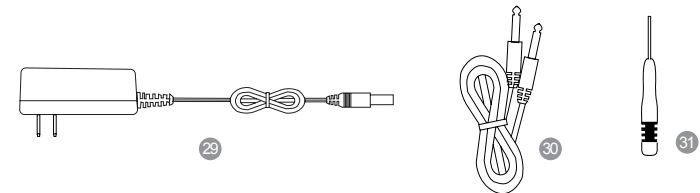

## 5. Connection

### 5-1 Receiver //

- (1) Connect to the subsequent unit (e.g. mixer, or amplifier)  
Connect one end of a proper AF cable to the AF Output ⑳ or AF Output mixed ㉑, then plug another end to the “MIC IN” input socket of a mixer or a amplifier (Step 1 of Figure 1)
- (2) Connect the power supply unit  
Plug in one end of AC/DC adaptor cable ㉒ to Power Supply Jack ㉓ in the rear panel of receiver, and plug another end into an AC outlet (Step 2 of Figure 1)

#### Caution

To prevent accidental disconnection of the plug of the power supply unit from the jack, lead the cable around the hook for strain relief. ㉔

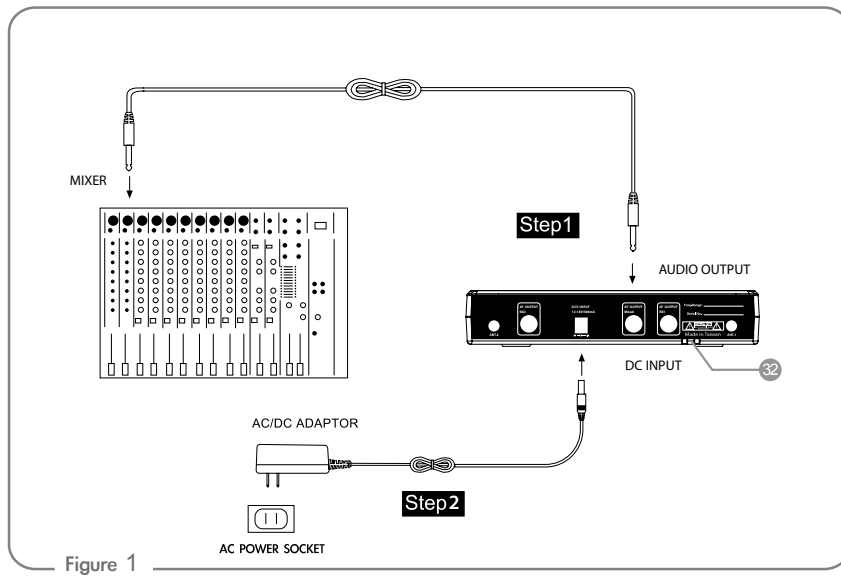

Figure 1

## 6. Operation

### 6-1 Setting US-936K receiver system

1. Turn on the power to the receiver
  - (1) Pull the receiver antenna out.
  - (2) Press the power switch ① to turn on the power.
  - (3) To turn off: Keep pressing the power switch down; the power is off about 1 second later.
2. Set the preset channels for receiver  
Press the Channel Select ⑥ ▲, ▼ keys to select US-936K preset channels; a total of 225 sets are available. A preset channel is displayed by the LED ⑦ while the corresponded frequency is displayed on LCD ⑧. Keeping ▲ or ▼ pressed down can change the channels faster. (Fig.2)

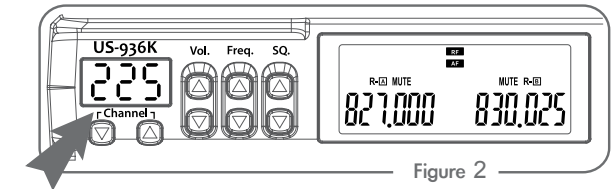

Figure 2

3. Frequency key  
If to adjust the frequency as you like rather than using a preset channel, press the Frequency key ④ ▲, ▼ to adjust the frequency at an increment of “+/-” 0.025MHz; keeping the ▲ or ▼ keys pressed down makes the frequency change faster. (Fig.3)

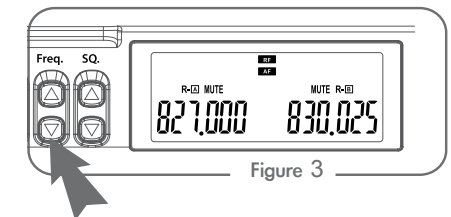

Figure 3

4. Volume key  
Press ③ ▲, ▼ to adjust the volume as needed in the range between 0 and 31dB; keeping the ▲ or ▼ keys pressed down makes the volume change faster. (Fig.4)

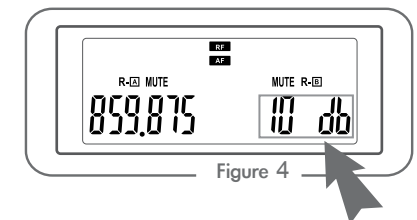

Figure 4

### 5. Squelch Key

Press **5** ▲, ▼ to adjust the squelch level between -10~+5; keeping the ▲ or ▼ keys pressed down makes the sensitivity adjustment faster, Press ▲, ▼ to adjust the squelch level between -10~+5; keeping the ▲ or ▼ keys pressed down makes the sensitivity adjustment faster. Pay attention to that the larger the SQ value the shorter the operation distance will be. (Fig.5)

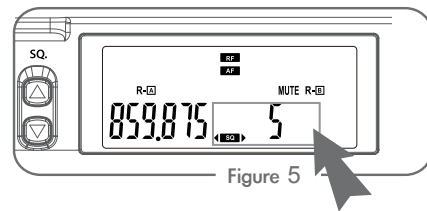

Figure 5

### 6. Lock key

When the setting of panel keys is complete, keep pressing the Lock key **2** and after about 2 seconds the panel keys are locked from being adjusted or set. To unlock, just keep pressing the Lock key for about 2 seconds. (Fig.6)

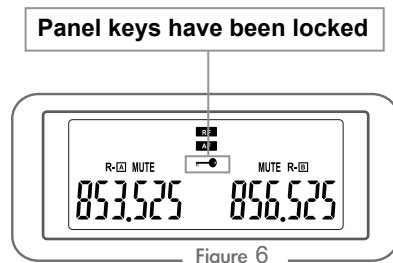
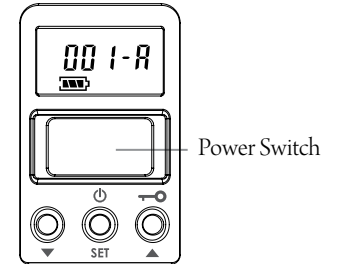

Figure 6

## 6-2 Setting the Mh-936K Handheld transmitter

### 1. Turn on the power

- (1) Press the Power switch **24** to turn on the power to the transmitter.
- (2) To turn off: Keep pressing down the Power switch and the power is off about 2 seconds later.



### 2. Adjusting frequency

# When setting the frequency as desired, make settings as 2-1 and 2-2.

#### 2-1 When frequency is displayed on screen

- (1) Press down SET key **27** for 2 seconds.
- (2) With the 3 digits on the left of the LCD blinking (Fig.7), press ▲ or ▼ keys to change the frequency at an increment of “+/-” 1MHz (keeping the ▲ or ▼ keys pressed down makes the number change faster). Press SET key to set, and the 3 digits on the right of the LCD blinking (Fig.8); press ▲ or ▼ keys to change the frequency at an increment of “+/-” 0.025MHz (keeping the ▲ or ▼ keys pressed down makes the number change faster). Press SET key to save the set value.

When these blink, adjust by +/- 1 MHz

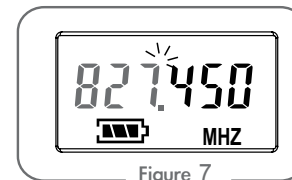

Figure 7

When these blink, adjust by +/- 0.025 MHz

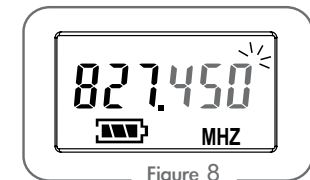

Figure 8

#### 2-2 When setting your desired frequency while a preset channel is displayed on screen:

- (1) Press down SET key **27** for 2 seconds.
- (2) The 3 digits on the left of the LCD begin to blink; press SET key twice to display the frequency on LCD (Fig.9), now adjust the frequency by the same step of “2-1 When frequency is displayed on screen – Point (2)”.

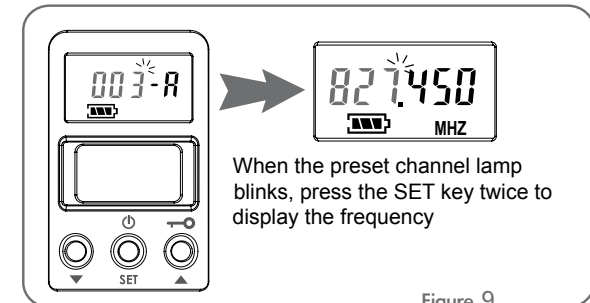



Figure 9

### 3. Using preset channels:

#### # When using preset channels, make settings as 3-1 and 3-2.

3-1 When a channel is displayed on LCD

- (1) Press down the SET key  for 2 seconds.
- (2) With the 3 digits on the left of the LCD blinking, press ▲, ▼ keys to change the preset channel (keeping the ▲, ▼ keys pressed down makes the channel change faster). Press SET key to set, and the letter A or B on the right of the LCD blinks; press ▲ to display b to select Channel B on the receiver; or, press ▼ display A to select Channel A on the receiver. After the selection is made, press SET key to save the set value (Fig.10).

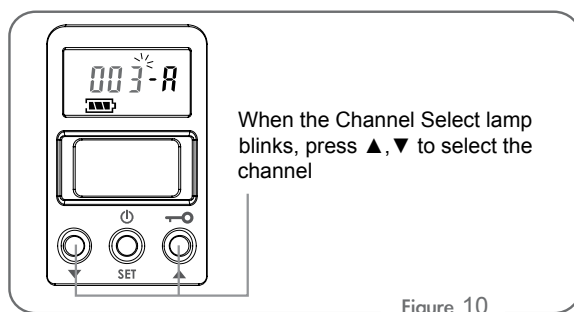



Figure 10

3-2 When using a preset channel while the frequency is displayed on screen:

- (1) Press down the SET key  for 2 seconds.
- (2) The 3 digits on the left of the LCD begin to blink; press SET key twice to display the channel on LCD (Fig.11), now adjust the channel by the same step of "3-1 When a channel is displayed on LCD – Point (2)".

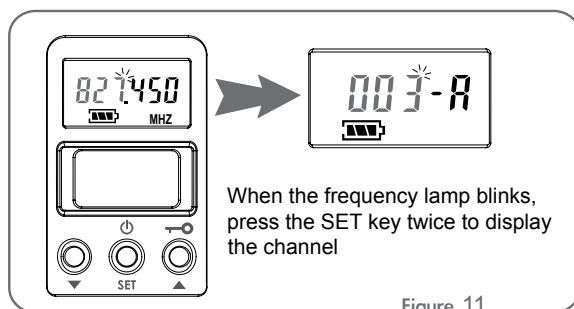



Figure 11

### 4. Adjusting microphone sensitivity

- (1) Press down the SET key  for 2 seconds.
- (2) The 3 digits on the left of the LCD begin to blink; press SET key four times to enter the sensitivity adjustment screen. (Fig.12)
- (3) press ▲, ▼ keys to adjust the microphone sensitivity in the range of -9-+12dB at an increment of 3dB. After the adjustment, press SET key to save the setting.

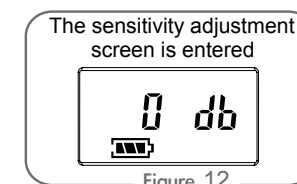



Figure 12

### 5. Adjusting transmission power

- (1) Press down the SET key  for 2 seconds.
- (2) The 3 digits of frequency or channel on the left of the LCD begin to blink; press SET key five times to display rF Lo (or rF Hi) on LCD. Press ▲ to display rF Hi to set as high transmission power; or press ▼ to display rF Lo to set as low transmission power. Press SET key to save the setting. (Fig.13)

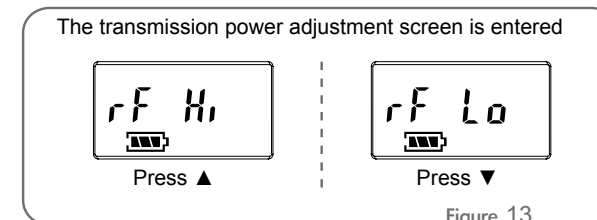

Figure 13

### 6. Setting key lock:

In a mode other than Setting mode, keep pressing down ▲ key for 2 seconds; when the screen displays Loc On, the handheld panel key functions are locked. To unlock, press down ▼ key for more than 2 seconds to display Loc OFF on screen, and the key lock is released. (Fig.14)

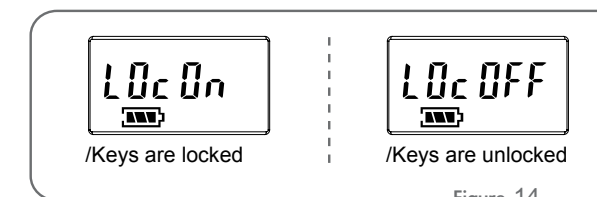

Figure 14



## 7. Recommendation

- (1) In order to achieve the optimum reception condition and also extend the operating distance, please leave a “open space” between the receiver and transmitter.
- (2) Keep the devices away from the metal objects or any interference sources, at least 50 cm.
- (3) To avoid the feed-back effect, don't leave the mic. to aim at the speakers directly.
- (4) For best pick-up pattern, please hold the middle of the mic. body.
- (5) Remove batteries from the battery compartment when the transmitter will not be used for a long time.
- (6) When you need to replace the batteries, please replace both batteries at the same time with new ones.

## 8. Important Notice

- (1) JTS offers wireless systems in a selection of bands that conform to the different government regulations of specific nations or geographic regions. These regulations help limit radio frequency (RF) interference among different wireless devices and prevent interference with local public communications channels, such as television and emergency broadcasts.
- (2) For information on bands available in your area, consult your local dealer or phone JTS. More information is also available at JTS's website ([www.jts.com.tw](http://www.jts.com.tw)).
- (3) This Radio apparatus may be capable of operating on some frequencies not authorized in your region. Please contact your national authority to obtain information on authorized frequencies and RF power levels for wireless microphone products.